

Klass Single Sided Desk

Assembly Instructions

Klass Single Sided Desk

Components List

A



2 x Column

B

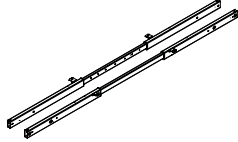

2 x Rail Assembly

C

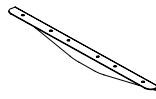

2 x Side Bracket

D

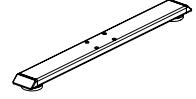

2 x Foot

E

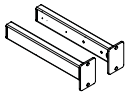

2 x Cable Tray Bracket
(optional)

F



2 x Studio50
Screen Bracket
(optional)

G

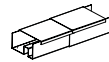

Cable Tray Bridge
(optional)

H

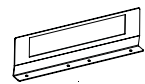

GPO Plate
(optional)

I

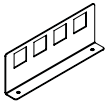

Data Plate
(optional accessories)

J

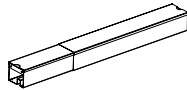

Adjustable Cable Tray
(optional accessories)

K

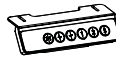

1 x Switch

L



1 x Control Box

M

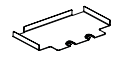

1 x Transformer Tray

N



1 x Power
Cord

O



1 x Extension
Cable

P



4 x M10x16
(accessory screws)

Q



4 x M8x10
(accessory screws)

R



8 x M6x16

S



34 x M6x10
(accessory screws)

T



4 x M6x8

U



10 x M5x12
(accessory screws)

V



12 x ST4.8x16

W



2 x ST3.5x16

X



6 x Cable Clip

Y



12 x Washer

Z



4 x Plastic Plug
(optional)

Tools:



1 x M5 Allen Key



1 x M4 Allen Key

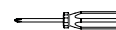



Screwdriver
(not included)

Klass Single Sided Desk

Assembly Instructions

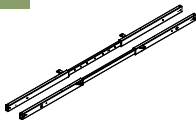
STEP 1:

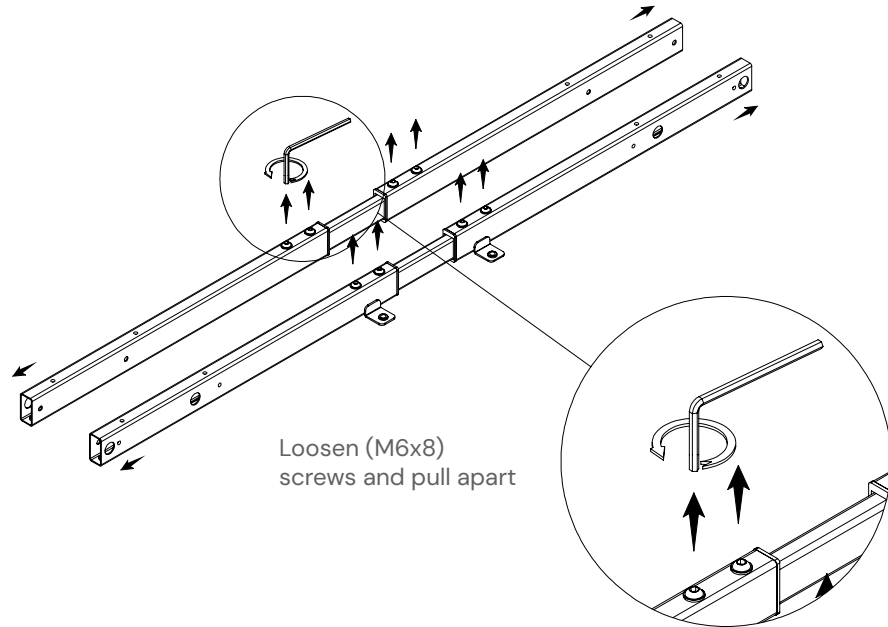

- B**

2 x Rail Assembly
- S**

8 x M6x10
- 
1 x M5 Allen Key

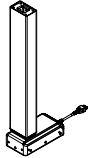

Helpful Tips:

Don't plug in the desk until handset & power box are mounted on to the desk top. It might cause errors.

STEP 2:

- A**

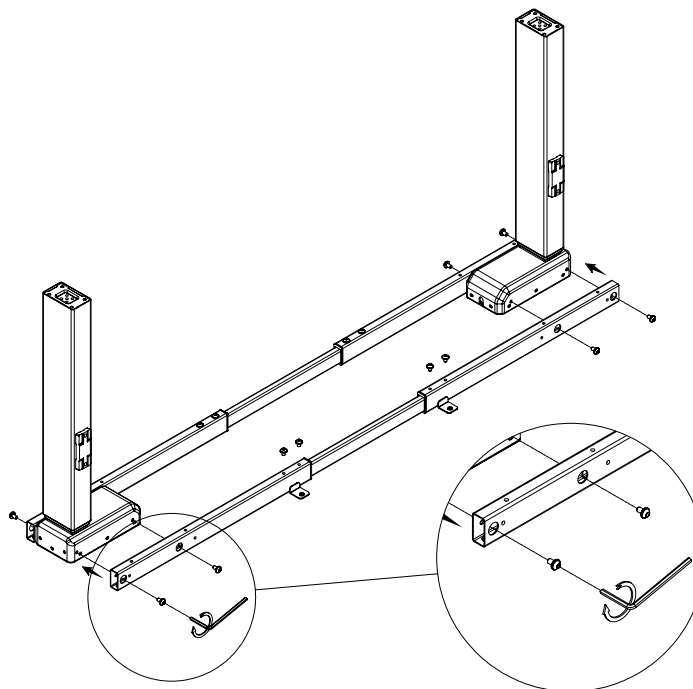
2 x Column
- S**

8 x M6x10
- 
1 x M5 Allen Key

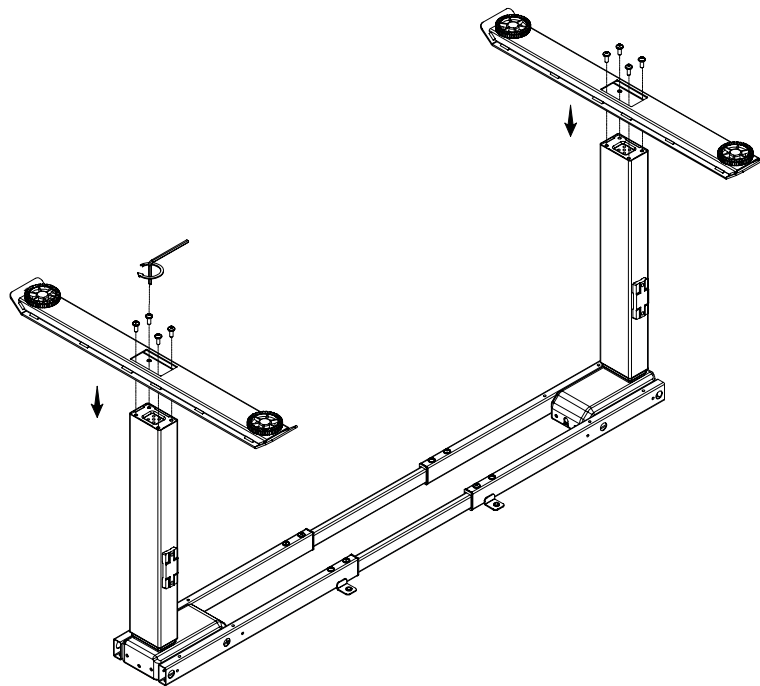

Klass Single Sided Desk

Assembly Instructions

STEP 3:



- D**





2 x Foot
- R**

8 x M6x16
- 
1 x M5 Allen Key

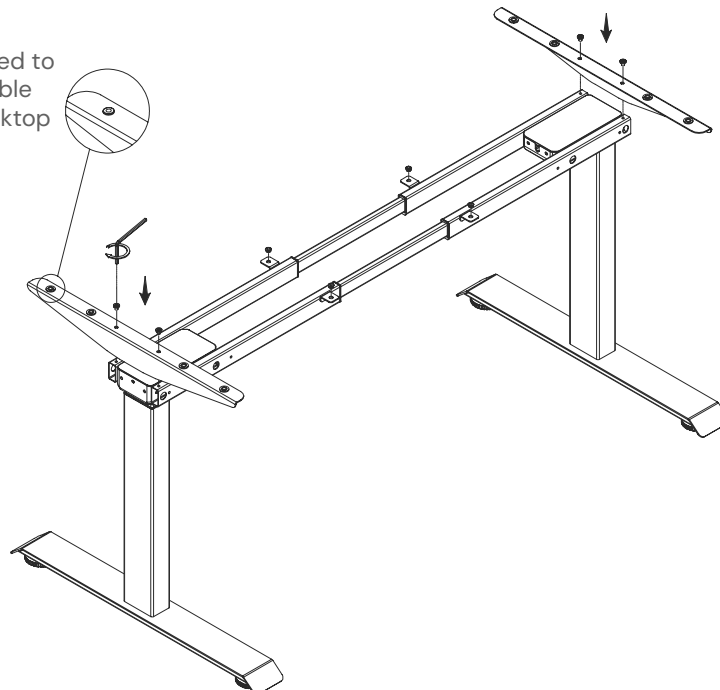
STEP 4:

These plugs are pre-assembled to ensure the frame remains stable during attachment to the worktop



- C**

2 x Side Bracket
- T**

4 x M6x8
- Y**

12 x Washer
- 
1 x M5 Allen Key

Helpful Tips:







Ensure that the washers are placed in the holes before fitting the worktop (Step 6).

Klass Single Sided Desk

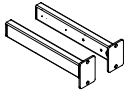
Assembly Instructions

STEP 5:

Skip to Step 8 if you don't have Cable Management.

- E**  2 x Cable Tray Bracket (optional)
- F**  2 x Studio50 Screen Bracket (optional)
- P**  4 x M10x16
- S**  4 x M6x10
-  1 x M5 Allen Key
-  1 x M4 Allen Key

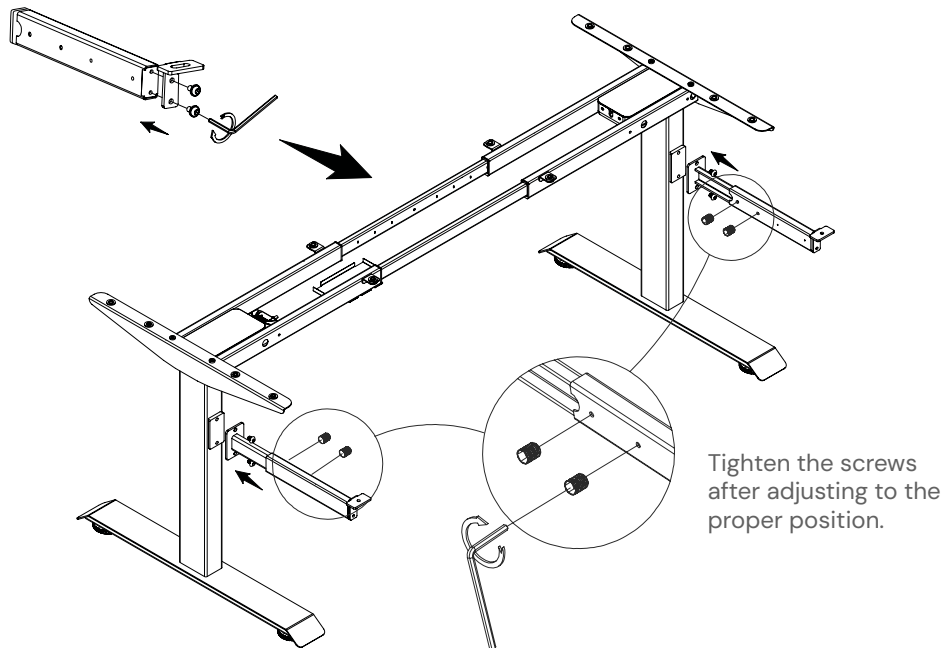





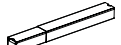

Tighten the screws after adjusting to the proper position.

Helpful Tips:

Don't plug in the desk until handset & power box are mounted on to the desk top. It might cause errors.

STEP 6:

- J**  Adjustable Cable Tray (optional)
- H**  GPO Plate (optional)
- I**  Data Plate (optional)
- S**  6 x M6x10
- U**  6 x M5x12
-  1 x M5 Allen Key
-  1 x M4 Allen Key

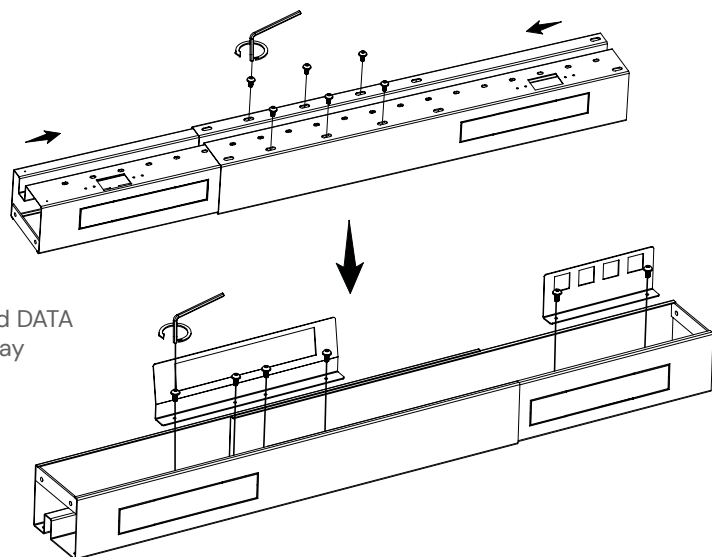

Install the GPO Plate and DATA Plate inside the cable tray with M5x12 screws.

Helpful Tips:

Remove the pre-installed screws from the cable tray, adjust to the proper position and then tighten the screws.

Klass Single Sided Desk

Assembly Instructions

STEP 7:

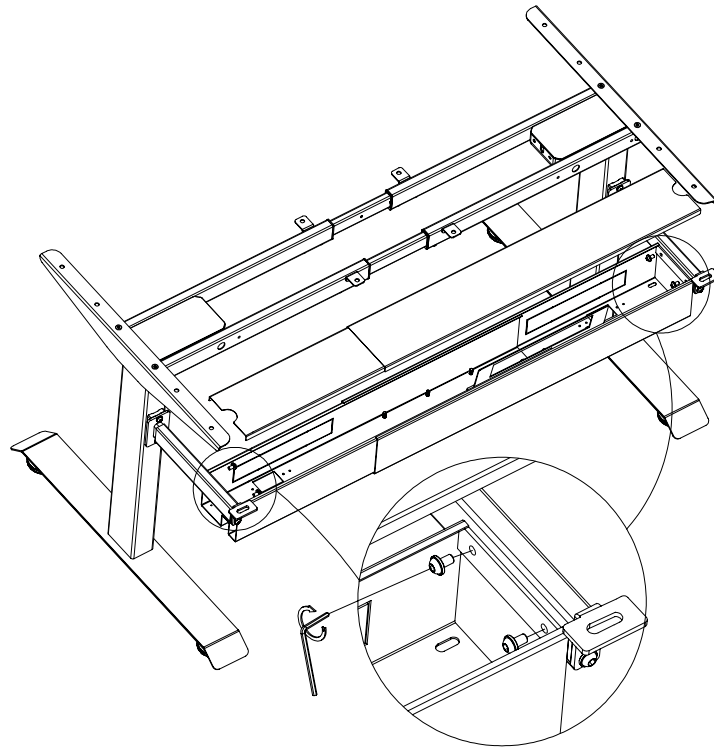

S



4 x M6x10



1 x M5 Allen Key

STEP 8:

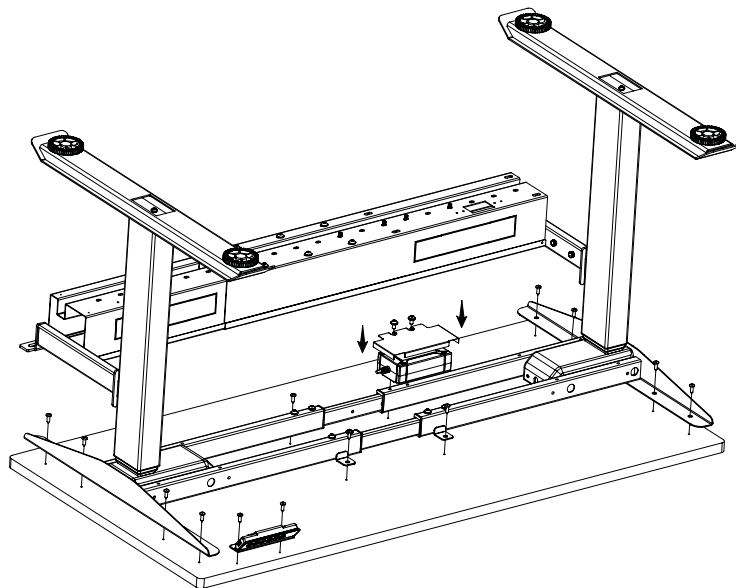

M

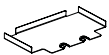

1 x Transformer Tray

L



1 x Control Box

K



1 x Switch

V



12 x ST4.8x16

W



2 x ST3.5x16



1 x M5 Allen Key

Klass Single Sided Desk

Assembly Instructions

STEP 9:

Cable Connection

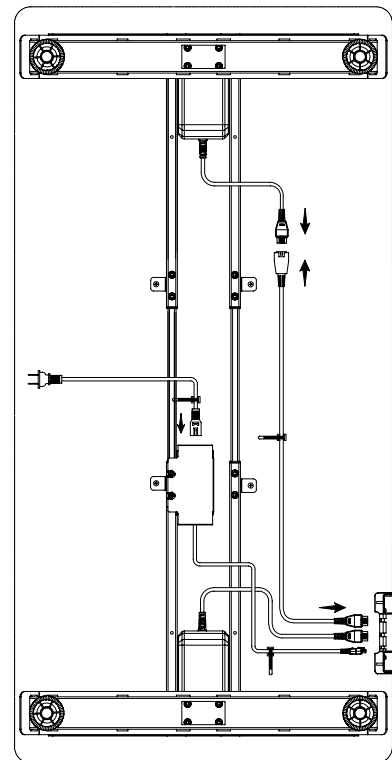
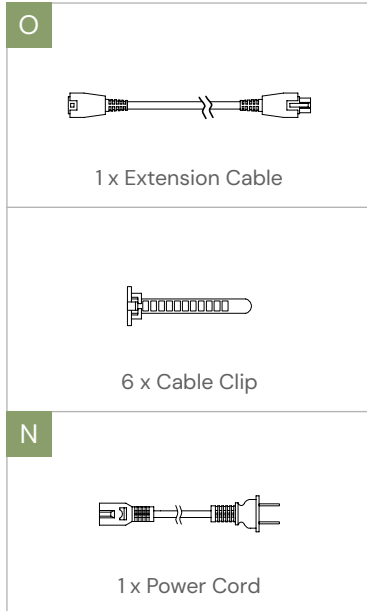

Helpful Tips:

Please ensure all cables are securely in place before connecting to power. Once connected to power, please perform a Manual Reset.

STEP 10:

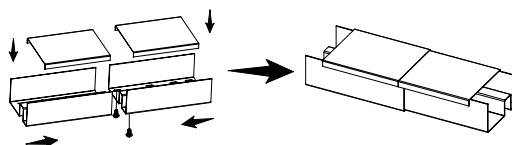
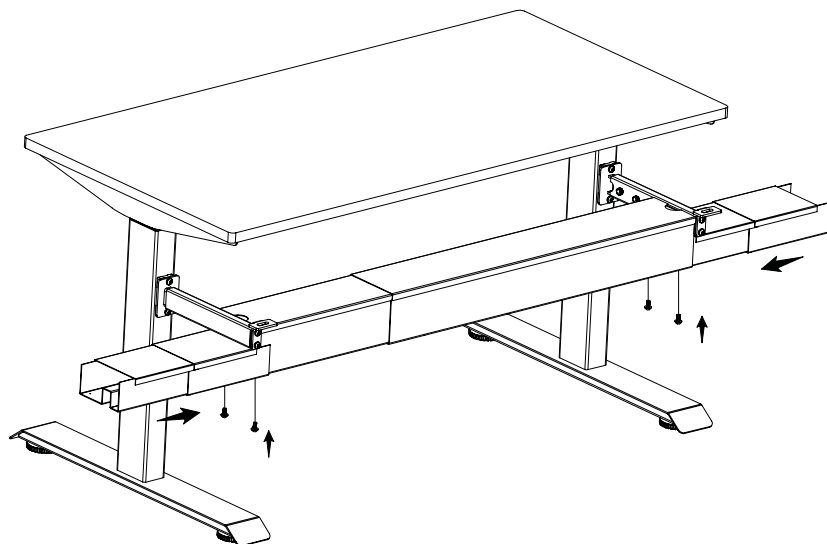
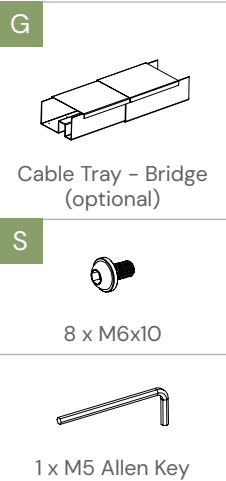







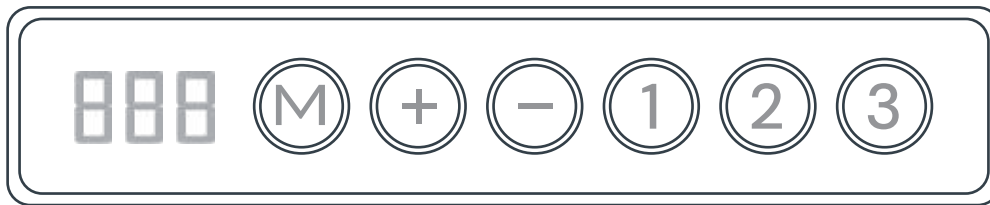





Adjust the adjustable cable tray to the proper position and then tighten it with M6x10 screws.

Klass Single Sided Desk

Direction for Use



MANUAL RESET		It is necessary to be reset manually after the initial installation and power off.
 		• Keep pressing down key until the desktop until display shows “E-1” and “rES” alternately and release the key.
		• Keep pressing down key, the desktop will move slowly down and return back until the display shows “063”.
 		• Release the key, the height-adjustable desk can be used normally.
<p>Note: The anti-collision function is not enabled during all resets. Please note that there is a potential risk of pinching in this case, and be sure no obstacles in the desk’s path.</p>		
UP AND DOWN		
		• Keep pressing up key until the required height is reached.
		• Keep pressing down key until the required height is reached.
SAVING POSITION		Press and hold the memory key until the columns have reached the desired memory position.
 		• Adjust the desktop to the height you want to save.
		• Press “M” key, until the display will show “S --”
		• Press “1”, and the display will show alternately as “S-1” and the desktop height.
		• Press “M” key, the first memory position is set successfully. Similar process for 2 and 3 memory positions.
ANTI-COLLISION FUNCTION		Before use, please make sure removing obstacle in advance and human body is in the safe position.
		• Once the desktop encounters any obstacle in its path, the screen displays “E-2”.
		• The desktop will move a defined distance in opposite direction, and it would be used normally after removing the obstacle.

Klass Single Sided Desk

Direction for Use

SET MINIMUM AND MAXIMUM HEIGHT	
Do not enable this function only when you are really need in some situation.	
	• Keep pressing the key "M" for 3 seconds until the display shows "S--" to enter setup menu.
 	• Press up key until the display flash as "HLP".
 	• Press "1", the display show alternately as "H-P" and current height.
 	• Keep pressing up or down key until the required upper limit position is reached.
	• Press "M", the desktop height will be showed and the shelf stop position has been set.
 	• Press "2", the display will show alternately "L-P" and current height, keep pressing down key until the lower limit position is reached, press M, the container stop position has been set.
Note: By this function would be used to limit the movement area of desktop, when the container is underneath or any shelf above the desktop. Once it is set, the new upper or lower limitation position will be stored.	
CHANGE THE DISPLAY UNIT(cm/inch)	
	• Keep pressing up key "M" until the display show "S--" to enter the setup menu.
 	• Press "up" key, the display will show "Unt".
	• Press "1", and the display will show alternately as "Unt" and the desktop height unit by "cm".
	• Press "M" key to save the unit as cm.
	• Press "2", and the display will show alternately as "Unt" and the desktop height unit by "inch", press the key "M" to save the unit as inch.
AMEND THE DESKTOP HEIGHT DISPLAYED	
 	• Keep pressing down key until the desktop until display shows "E-1" and "rES".
	• Keep pressing key "M" until the display show "Ur" and "OFF" alternately.
 	• Keep "Up" or "Dn" several times, until the display show "End" and height. (In this case, the unit is mm or inch when this system's metric or imperial)
  	• Press "1","2" and "3" respectively, and to adjust the first number, the second number and the third number. If you click one, the number will increase by 1, until you get to the value you want.
	• Press "M" the height has been changed to defined digit.
Note: The function enables you to change the height shows on the display based on the actual measurement.	

Klass Single Sided Desk

Direction for Use

CHANGE THE DISPLAY UNIT(cm/inch)		The function can detect whether the motors are collected normally.
E-3 rES	<ul style="list-style-type: none"> Once the display shows "E-3" and "rES", it reminds you check whether any motors fail connected with control unit. Please connect the main cable again, wait at least 5 seconds. 	
	<ul style="list-style-type: none"> Collect all the plugs. 	
rES	<ul style="list-style-type: none"> Follow manual reset procedure. 	
RESET TO FACTORY SETTING		With this function, you can make the control unit to factory setting.
M	<ul style="list-style-type: none"> Keep pressing "M" until the display shows "FAC". 	
	<ul style="list-style-type: none"> Press "M", and the control unit to factory setting (including memory position, container - and shelf - stop position, etc). 	

CODE MEANING

Code	Information	Operating
rES	Manual resetting	Refer to the progress of manual reset
ovr	Overloading	Remove the load on desktop till it less than 800N (175 LBS) for further operation
E-2	Anti-Collision function	It can be used normally after removing the obstacle
dut	Operated continuously without suitable rest	Make the desk rest around 15min for further operation

Klass Single Sided Desk

Direction for Use

TROUBLE SHOOTING	
Code	Operating
E-4 / The height between two legs exceed 1 inch	Stop the operation and reset, refer to Manual reset
E-3	Check the cables and ensure they are well connected, and the height-adjustable desk can be used normally after manual reset

TECHNICAL DATA	
Item	Data
Input voltage	100~240VAC
Output voltage	24VDC
Max loading	1000N
Height range (without desktop)	595 – 1245
Duty cycle	2 min on / 18 min off



1300 99 77 47

officefurniturecompany.com.au

Disclaimer

The products in this document are distributed and warranted by OLG. All product specifications, warranties, and after-sales support are the responsibility of OLG.