

# Klass Double Sided Desk

Assembly Instructions

# Klass Double Sided Desk

## Components List

A

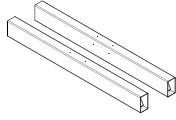

2 x Vertical Connecting Pipe

B

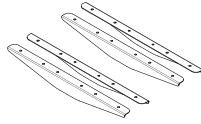

4 x Side Bracket

C

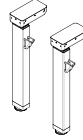

2 x Right Column

D

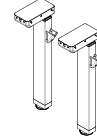

2 x Left Column

E

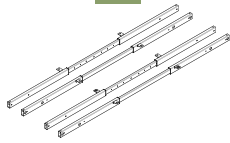

4 x Rail

F

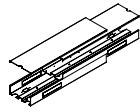

1 x Cable Tray Cover (optional)

G

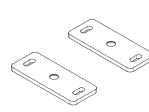

2 x Plate (optional)

H

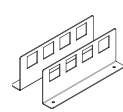

2 x Data Plate

I

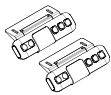

2 x Switch

J

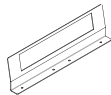

1 x GPO Plate

K

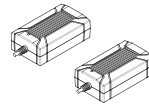

2 x Control Box

L

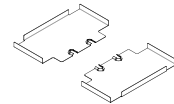

2 x Transformer Tray

M



2 x Power Cord

N



4 x Extension Cable

O



4 x M6x16 Screw

P



28 x M6x10 Screw

Q



8 x M8x18 Screw

R



16 x ST4.8x16 Screw

S



6 x M5x12

T



4 x ST3.5x16 Screw

U



12 x M6x8 Screw

### Tools:



1 x M6 Allen Key



1 x M4 Allen Key

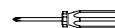

Screwdriver (not included)

# Klass Double Sided Desk

## Assembly Instructions

### STEP 1:

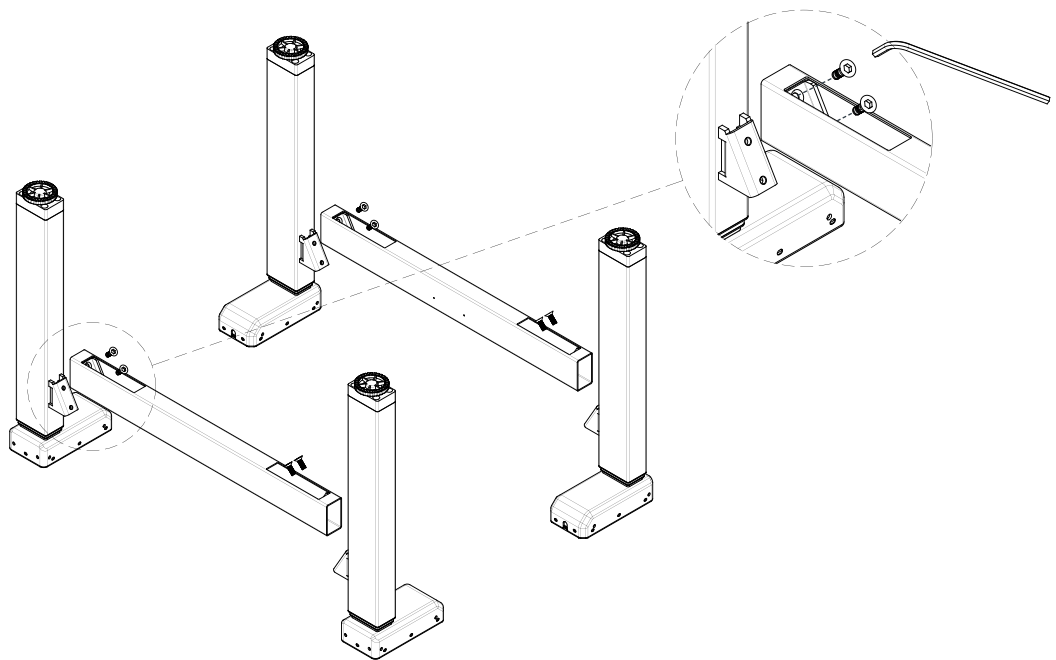
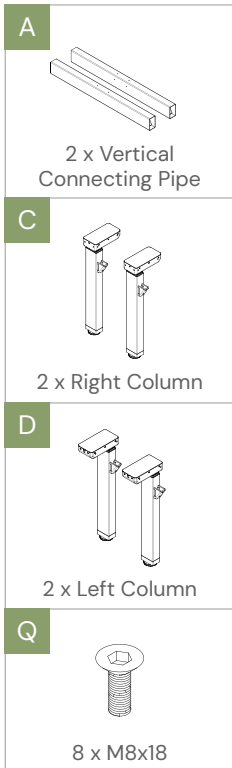

**Helpful Tips:** Pre-tighten the vertical connecting pipe and column by screws.

### STEP 2:

If you don't have a cable management tray, skip to Step 4.

The number of GPO plates and DATA plates is selected by you, and the number of screws is configured according to the selecting results.

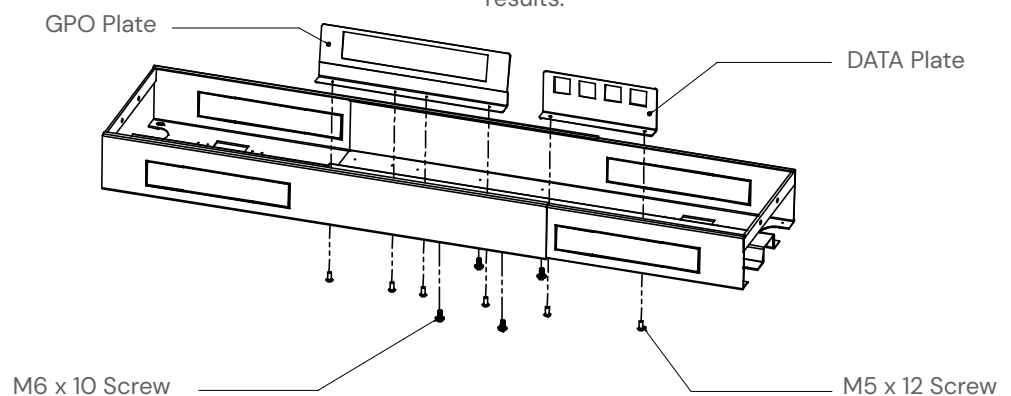
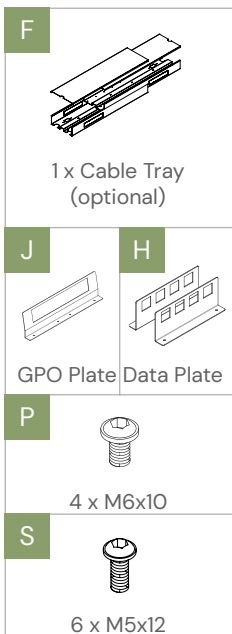





**Helpful Tips:**

The number of M6 x 10 illustrated is 4, the optional number is 4-8; To adjust the length of the trunking, you need to remove the two screws that were originally fixed.

# Klass Double Sided Desk

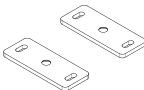
## Assembly Instructions

### STEP 3:

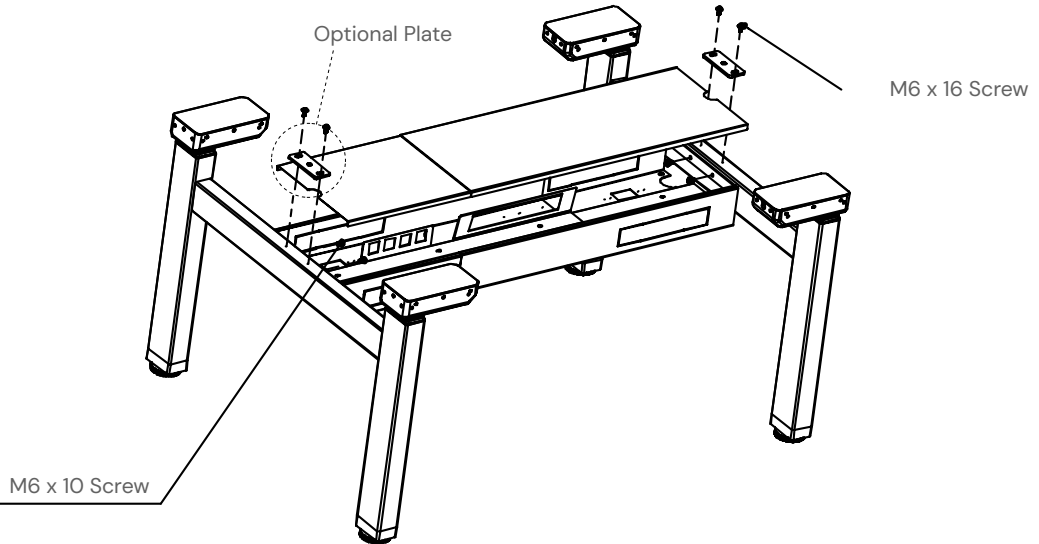

- G**  
  
2 x Plate (optional)
- O**  
  
4 x M6x16
- P**  
  
4 x M6x10
-   
1 x M5 Allen Key



#### Helpful Tips:

Install the cable tray cover after locking the cable tray screws; Install the optional plate (if Studio50 Screen is required) and tighten the screws.

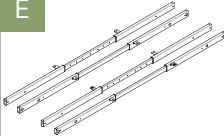
### STEP 4:

- E**  
  
4 x Rail
- P**  
  
16 x M6x10
-   
1 x M5 Allen Key

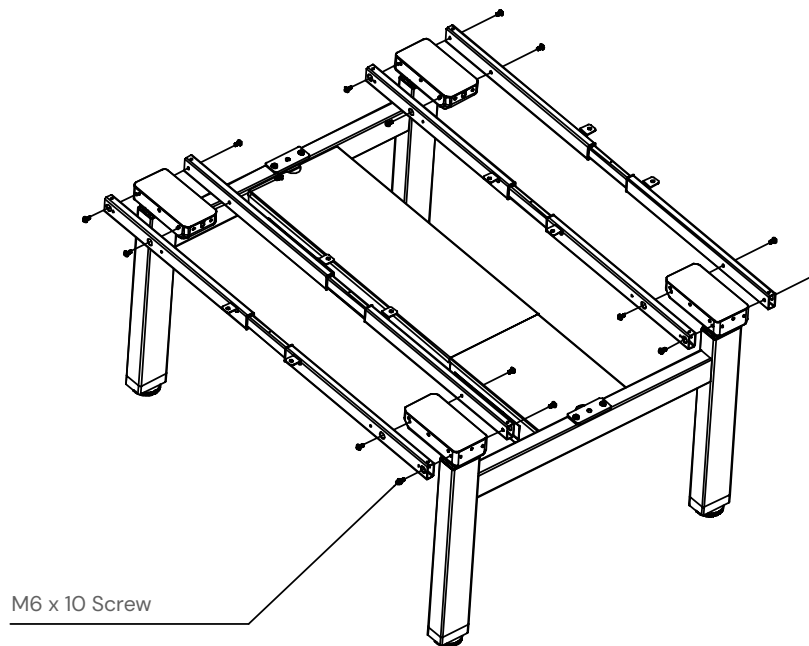

#### Helpful Tips:

Pre-tighten the vertical connecting pipe and column by screws.

# Klass Double Sided Desk

## Assembly Instructions

### STEP 5:

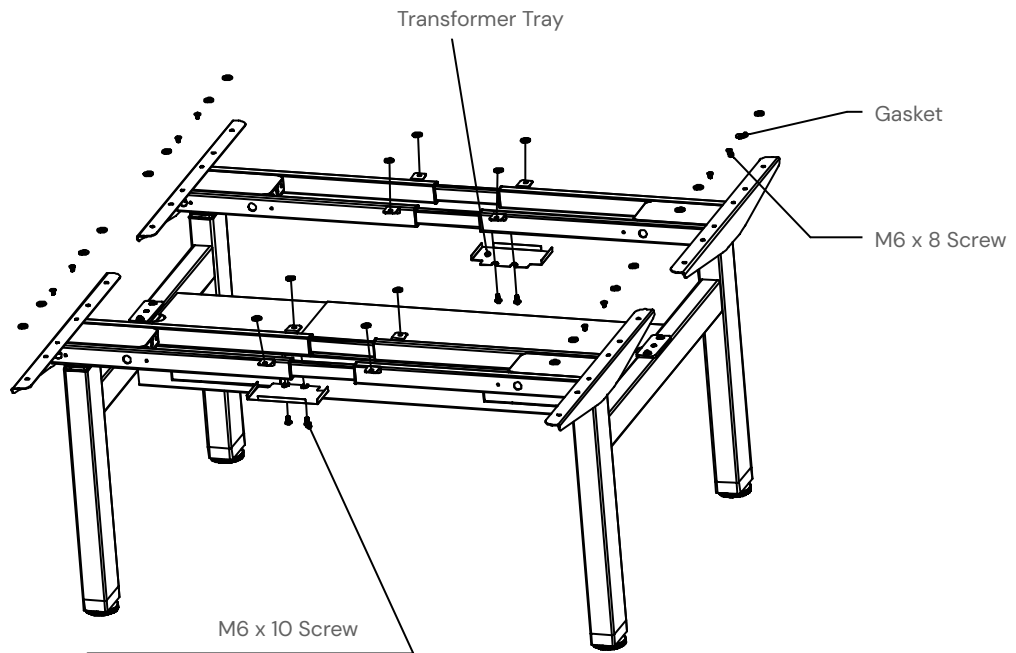
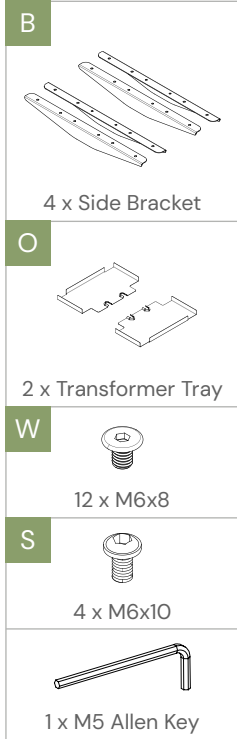

#### Helpful Tips:

Insert the side brackets into column and tighten the screws; Lock the transformer tray and install the gasket.

### STEP 6:

ST4.8 x 16 Tapping Screw

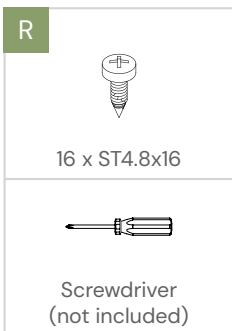
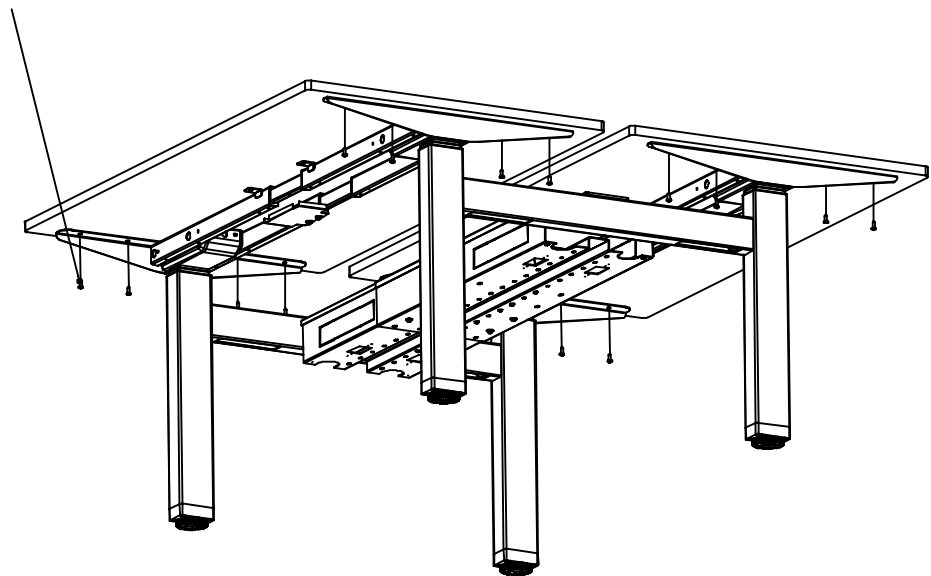

#### Helpful Tips:

It is suggested to position the worktop plates 25mm from the edge of the desktop and tighten screws.



# Klass Double Sided Desk

## Assembly Instructions

### STEP 7:

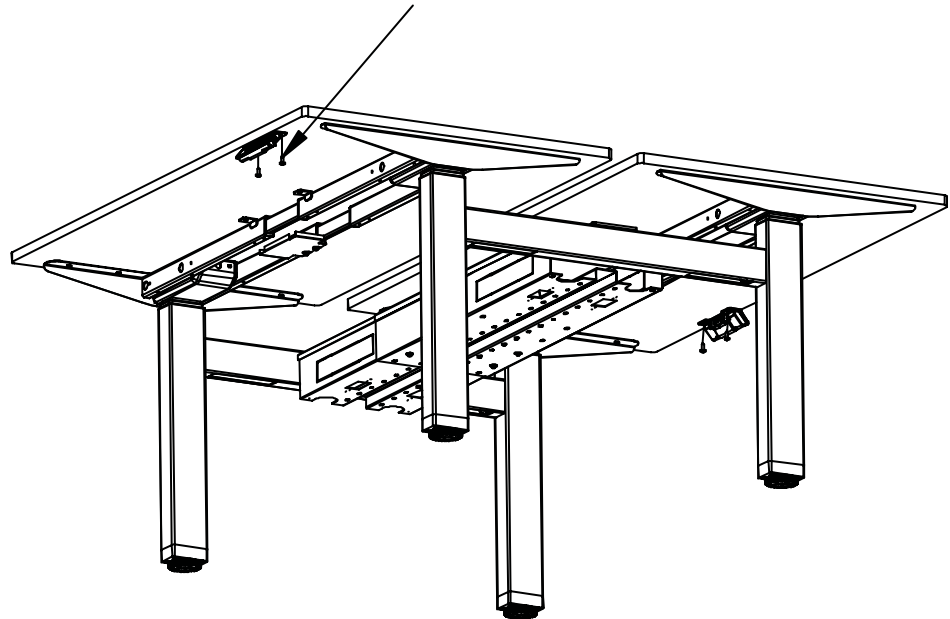
ST3.5 x 16 Tapping Screw

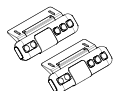

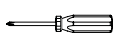
I	
	2 x Switch
T	
	4 x ST3.5x16
	
	Screwdriver (not included)

#### Helpful Tips:

Install the switch on suitable position of desktop edge to avoid interference with humans or chairs, display screen facing out, and tighten screws.

### STEP 8:

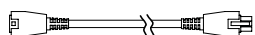
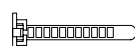
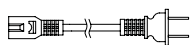
N	
	4 x Extension Cable
	
	6 x Cable Clip
M	
	2 x Power Cord

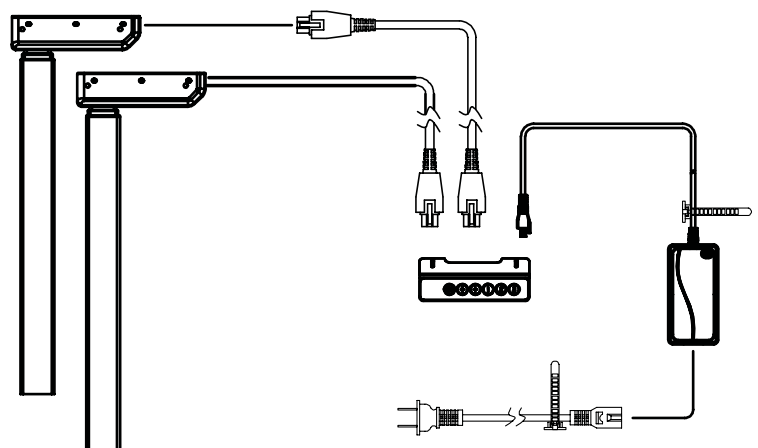









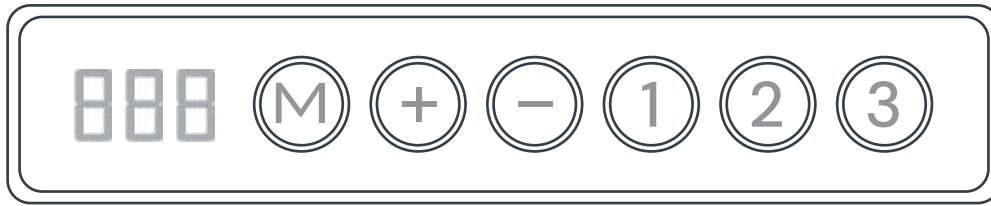



#### Helpful Tips:

Tidy up all the power cables with cable clip.

# Klass Double Sided Desk

## Direction for Use



<b>MANUAL RESET</b>		It is necessary to be reset manually after the initial installation and power off.
 		• Keep pressing down key until the desktop until display shows “E-1” and “rES” alternately and release the key.
		• Keep pressing down key, the desktop will move slowly down and return back until the display shows “063”.
 		• Release the key, the height-adjustable desk can be used normally.
<p>Note: The anti-collision function is not enabled during all resets. Please note that there is a potential risk of pinching in this case, and be sure no obstacles in the desk’s path.</p>		
<b>UP AND DOWN</b>		
		• Keep pressing up key until the required height is reached.
		• Keep pressing down key until the required height is reached.
<b>SAVING POSITION</b>		Press and hold the memory key until the columns have reached the desired memory position.
 		• Adjust the desktop to the height you want to save.
		• Press “M” key, until the display will show “S --”
		• Press “1”, and the display will show alternately as “S-1” and the desktop height.
		• Press “M” key, the first memory position is set successfully. Similar process for 2 and 3 memory positions.
<b>ANTI-COLLISION FUNCTION</b>		Before use, please make sure removing obstacle in advance and human body is in the safe position.
		• Once the desktop encounters any obstacle in its path, the screen displays “E-2”.
		• The desktop will move a defined distance in opposite direction, and it would be used normally after removing the obstacle.

# Klass Double Sided Desk

## Direction for Use

SET MINIMUM AND MAXIMUM HEIGHT	
Do not enable this function only when you are really need in some situation.	
	• Keep pressing the key "M" for 3 seconds until the display shows "S--" to enter setup menu.
	• Press up key until the display flash as "HLP".
	• Press "1", the display show alternately as "H-P" and current height.
	• Keep pressing up or down key until the required upper limit position is reached.
	• Press "M", the desktop height will be showed and the shelf stop position has been set.
	• Press "2", the display will show alternately "L-P" and current height, keep pressing down key until the lower limit position is reached, press M, the container stop position has been set.
Note: By this function would be used to limit the movement area of desktop, when the container is underneath or any shelf above the desktop. Once it is set, the new upper or lower limitation position will be stored.	
CHANGE THE DISPLAY UNIT(cm/inch)	
	• Keep pressing up key "M" until the display show "S--" to enter the setup menu.
	• Press "up" key, the display will show "Unt".
	• Press "1", and the display will show alternately as "Unt" and the desktop height unit by "cm".
	• Press "M" key to save the unit as cm.
	• Press "2", and the display will show alternately as "Unt" and the desktop height unit by "inch", press the key "M" to save the unit as inch.
AMEND THE DESKTOP HEIGHT DISPLAYED	
	• Keep pressing down key until the desktop until display shows "E-1" and "rES".
	• Keep pressing key "M" until the display show "Ur" and "OFF" alternately.
	• Keep "Up" or "Dn" several times, until the display show "End" and height. (In this case, the unit is mm or inch when this system's metric or imperial)
	• Press "1","2" and "3" respectively, and to adjust the first number, the second number and the third number. If you click one, the number will increase by 1, until you get to the value you want.
	• Press "M" the height has been changed to defined digit.
Note: The function enables you to change the height shows on the display based on the actual measurement.	

# Klass Double Sided Desk

## Direction for Use

<b>CHANGE THE DISPLAY UNIT(cm/inch)</b>		The function can detect whether the motors are collected normally.
<b>E-3</b> <b>rES</b>	<ul style="list-style-type: none"> <li>Once the display shows "E-3" and "rES", it reminds you check whether any motors fail connected with control unit. Please connect the main cable again, wait at least 5 seconds.</li> </ul>	
	<ul style="list-style-type: none"> <li>Collect all the plugs.</li> </ul>	
<b>rES</b>	<ul style="list-style-type: none"> <li>Follow manual reset procedure.</li> </ul>	
<b>RESET TO FACTORY SETTING</b>		With this function, you can make the control unit to factory setting.
<b>M</b>	<ul style="list-style-type: none"> <li>Keep pressing "M" until the display shows "FAC".</li> </ul>	
	<ul style="list-style-type: none"> <li>Press "M", and the control unit to factory setting (including memory position, container - and shelf - stop position, etc).</li> </ul>	

## CODE MEANING

Code	Information	Operating
rES	Manual resetting	Refer to the progress of manual reset
ovr	Overloading	Remove the load on desktop till it less than 800N (175 LBS) for further operation
E-2	Anti-Collision function	It can be used normally after removing the obstacle
dut	Operated continuously without suitable rest	Make the desk rest around 15min for further operation

# Klass Double Sided Desk

## Direction for Use

TROUBLE SHOOTING	
Code	Operating
E-4 / The height between two legs exceed 1 inch	Stop the operation and reset, refer to Manual reset
E-3	Check the cables and ensure they are well connected, and the height-adjustable desk can be used normally after manual reset

TECHNICAL DATA	
Item	Data
Input voltage	100~240VAC
Output voltage	24VDC
Max loading	1000N
Height range (without desktop)	595 – 1245
Duty cycle	2 min on / 18 min off



1300 99 77 47

[officefurniturecompany.com.au](http://officefurniturecompany.com.au)

---

#### **Disclaimer**

The products in this document are distributed and warranted by OLG. All product specifications, warranties, and after-sales support are the responsibility of OLG.